

# EG Series Electric Gage & Swichgage® Instrument

The EGS21 Series Swichgage instrument has all of the features of the EG21 Series Gage plus an adjustable set point Power Hall Effect switch output for operating alarms or equipment shutdown. The trip point is adjustable over 90 percent of the scale and has a set point indicator visible from the gage face. Now you can have both the ease of electric gage installation and the reliable switching of Murphy's famous Swichgage instrument.

Features of the EG Series include:

- EG Air Core Movement design
- Technological improvements in lighting, accuracy in reading and wiring installation
- Environmentally sealed design
- Exceeds the rigid SAE J1810 standard
- Corrosion-resistant materials
- Desirable for marine and other environmentally sensitive applications
- Soft, non-glare dial and pointer illumination by cold light LED

## Specifications

**Power Input:** For Gage, Swichgage instrument and sender, 12 VDC or 24 VDC

**NOTE:** EG21 Series gage and EGS21 Series Swichgage instrument MOVEMENT and ILLUMINATION require 12 VDC to function.

For 24-volt systems, voltage converters are built into the electrical wire/connector assembly and supplied with instrument. Specify voltage when ordering.

**Case:** Polyester (PBT), impact and weather resistant with convenient screw-on mounting clamp

**Bezel:** Polished 316 stainless steel bezel is supplied as standard; Available in black. SAE style optional.

**Lens:** Clear polycarbonate and UV stabilized

**Air Core Movement:** Silicon dampened pointer

**Dial:** Black background and white markings; behind dial lighting (white marking becomes red when illuminated); dual scale with mirror band to reduce parallax reading errors

**Swichgage Instrument Sensor:** Outputs ground signal (sinking output) rated 300 mA continuous (EGS21 Series only). Pressure, fuel, volts set on decreasing scale. Temperature and amps set on increasing scale.

**Output saturation voltage (voltage drop across switch):** 1.3-2.3 Volts @ 77°F (25°C) (May require some conditioning to work with logic inputs)

**Swichgage Instrument Set Point Indicator:** Visible on mirror band (scale); adjustable from the back of the unit (1/16 in. hex type wrench)

**Wiring:** Plug connector with wire leads, 18 AWG (1.0 mm<sup>2</sup>) x 8 in. (203 mm) length

**Operating Temperature:** -40° to 185°F (-40° to 85°C)

**Storage Temperature:** -77° to 185°F (-60° to 85°C)

**Over Voltage (Gage Movement):** Withstands a voltage of 200% of nominal system voltage for 5 minutes. (Meets SAE J1810 standards)

**Reversed Polarity (Gage Movement):** Withstands reversed battery terminal polarity indefinitely within operating temperatures

**Environment and Test:** Meets SAE J1810 standards





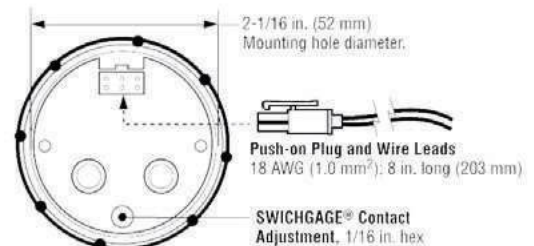
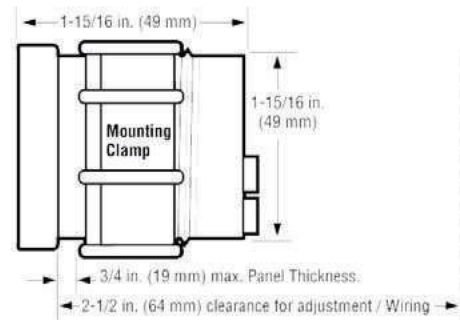

## Dimensions

SWICHGAGE Adjustable Contact Indicator  
Reflective Mirror Band



## Gage Ranges

	Pressure	80 psi	552 kPa	5.52 bar
		100 psi	689 kPa	6.89 bar
		200 psi	1.38 MPa	13.80 bar
		300 psi	2.07 MPa	20.70 bar
		400 psi	2.76 MPa	27.60 bar
	Temperature	250° F	121° C	
		300° F	149° C	
	Fuel Level	Empty – 1/4 – 1/2 – 3/4 – Full		
	Ammeter	60 – 0 – 60 amps (internal shunt)		
	Voltmeter	12 VDC: 8-18 Volts		
		24 VDC: 16-36 Volts		

## How to Order

Options listed below. All configurations may not be available. Call your sales representative or Enovation Controls for more information.

### EG Series Gage and Swichgage Instrument

**EGS21 P - 100 - 12 - A**

#### Base Model

EG21 = Gage  
EGS21 = Swichgage

#### Measurement Units

P = Pressure  
PV = Pressure Special\*  
TV = Temperature Special\*\*  
T = Temperature

F = Fuel  
AM = Ammeter  
VM = Voltmeter

#### Range Scale

Show maximum value and units of measure (if other than psi or °F) for Pressure, Temperature, Amps, and Volts

#### Bezel

Standard = Polished Stainless Steel  
A = Black, Semi-Gloss Finish  
B = SAE Low Profile Stainless

#### Battery Voltage

12 = 12 VDC systems  
24 = 24 VDC systems

**NOTE:** EG21 and EGS21 are designed for use with 12-volt systems. For 24-volt systems, voltage reducing resistors are included in the wire/connector assembly. No designator required for Standard configurations.

\* The **EG21PV-80-12** or 24 is designed to read senders with a resistance curve of 9.5 to 182 Ohms, which are commonly supplied as standard senders on Deutz and VW engines.

\*\*The **EG21TV-300-12** or 24 is designed to read senders with a resistance of 240 to 18 Ohms, which are commonly supplied as standard senders on Deutz and VW engines.

#### CONTACT

#### RAJKOT MARINE LLC